

Design and Evaluation of the 792A AC/DC Transfer Standard

Application Note

In the past, when a calibration laboratory was required to make very accurate ac voltage measurements—20 ppm or better in the audio range—the only suitable measurement devices were single or multijunction thermal elements. Unfortunately, these thermocouple based thermal elements suffer from several drawbacks that severely limit their usefulness in a budget conscious calibration laboratory. These include:

- Long settling times.
- Extreme sensitivity to external temperature.
- Difficulty measuring low level nonlinear output (in the case of single junction devices).
- No voltage measurement capability below 250 mV.
- Susceptibility to damage from even moderate overloads.

Practically speaking, these drawbacks have meant long, difficult calibrations that usually required the services of a skilled metrologist. It is an expensive process with low throughput. Clearly, there had to be a better way.

This technical note describes an ac/dc thermal transfer standard—the Fluke 792A—that was developed as a practical method for making ac voltage measurements at the best accuracies available from national standards. The 792A uses a proprietary solid-state thermal converter for its basic rms to dc conversion. While fast settling time and a large output voltage are provided by the rms converter itself, the instrument also includes voltage scaling to allow inputs from 2 mV to 1000V and protection from overloads over the entire input range.

Design

The RMS Sensor. The pivotal component in the 792A is the Fluke solid-state rms sensor which has been proven in several products. A simplified diagram of the rms sensor is shown in Figure 1. The sensor chip itself consists of two closely matched thermal voltage converters that use the temperature sensitivity of the transistor base-emitter junction in the place of the traditional thermocouple.

External to the sensor chip is an error amplifier that is used to drive the second or feedback resistor/transistor pair. The output of the circuit is a dc voltage linearly proportional to the rms value of the input signal.

Design requirements necessitated several modifications to the sensor and essentially pushed the sensor design to obtain the low noise, wide dynamic range, and fast settling time needed.

A low noise transistor process was developed for the temperature sensing transistors to provide the best possible noise performance and dynamic range. Figure 2 shows the voltage noise of two 'old process' sensors along with a reference low noise transistor pair. The new low noise process is recorded in Figure 3, again with the same low noise transistor pair reference.

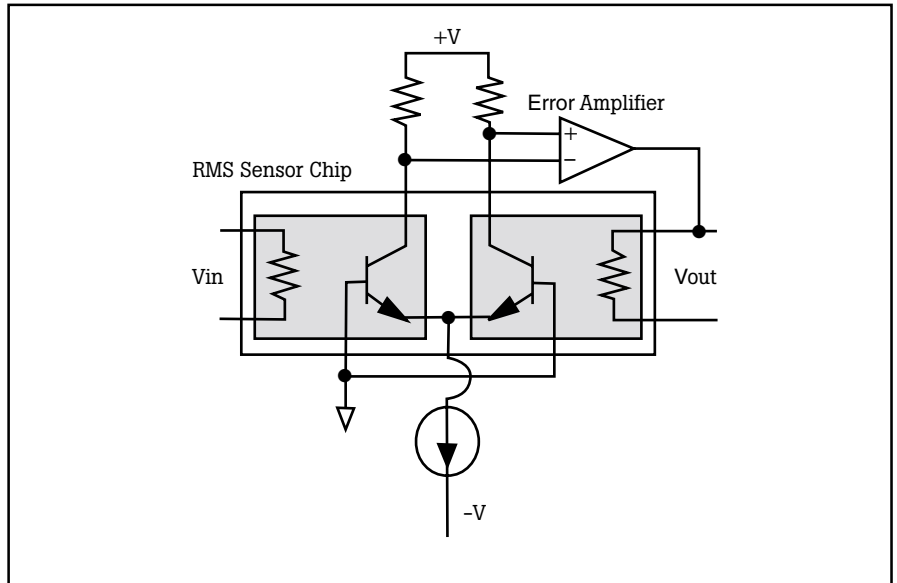

Figure 1. Simplified RMS Sensor Circuit

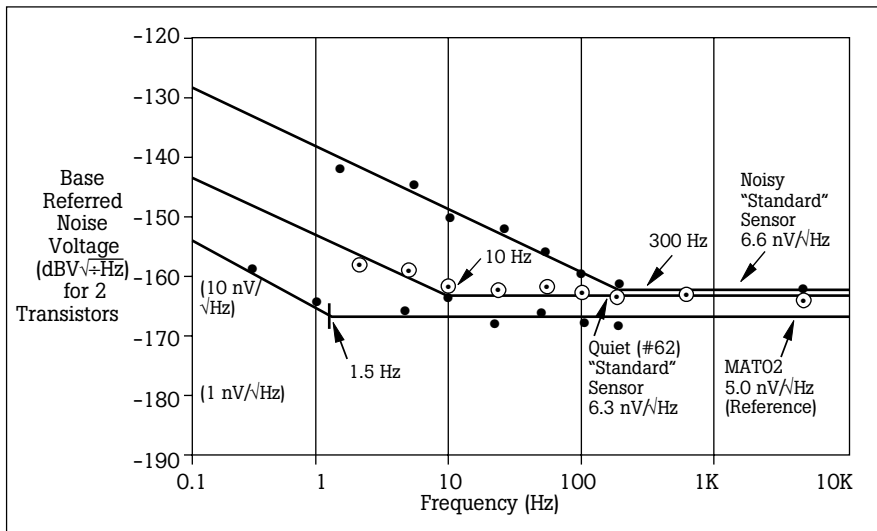

Figure 2: Base Referred Voltage Noise: Original Sensor

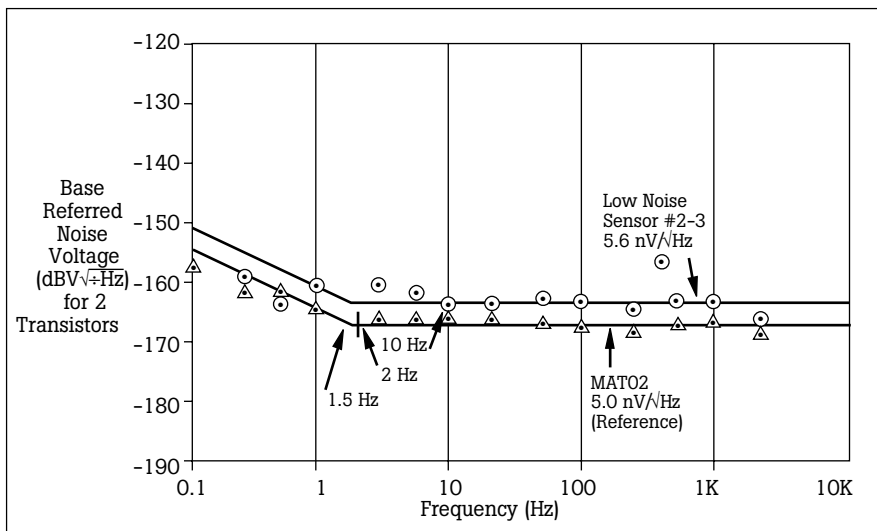

Figure 3: Base Referred Voltage Noise: Improved Sensor

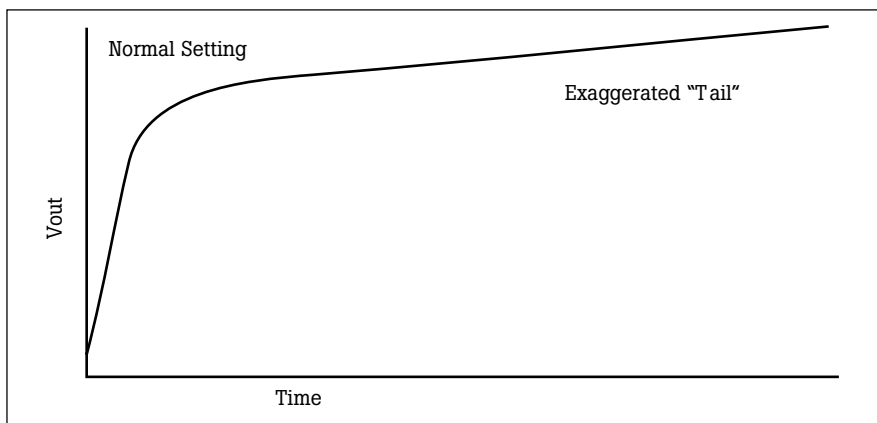

Figure 4: RMS Sensor Output Settling Before Thermal Improvements

Measurements at full scale are typically repeatable to within 0.5 ppm. The small physical size of the rms sensor and the close matching of the two individual converters within it produced a fast settling output voltage. Early designs, however, showed a slow "tail" to the settling response (Figure 4) which was reduced to an insignificant level by changing the packaging of the rms sensor to minimize thermal gradients between the individual converters.

An unfortunate side effect of the sensor's fast settling time was discovered to be poor performance with low frequency inputs. As the frequency of the input waveform decreased, the output of the rms sensor began to track the slowly varying input signal. This tracking phenomenon, which appears as ripple on the output voltage, is present to some degree on all thermal rms converters.

Filtering, both inside and outside the sensor feedback loop, removes this ripple and recovers the proper dc output down as low as 10 Hz.

Passive Ranging. For input voltages above the 2.2V full scale of the rms sensor, the 792A uses the simple resistive divider approach shown in Figure 5. The range resistors chosen are proprietary hermetic thin film hybrids that have very stable ac characteristics as well as temperature coefficients (t_c) less than 1 ppm/degree C. This low t_c , combined with a good thermal design, allows all of the passive ranges to settle just as fast as the 2.2V range.

Because the 1000V range resistor can dissipate 5W or more, it was moved outside of the main unit into its own enclosure. This approach worked better than expected and the 1000V range settles faster than most calibrator 1000V outputs, while retaining ac/dc difference better than most primary standards at that level.

One of the most critical components in the 792A's design is the range switch. The switch finally chosen after extensive research is a custom version of a radio transmitter switch.

This switch is ideally suited for range switching for a number of reasons. The heavy duty silver plated copper contacts have very low thermal emfs for low turnover error, contact resistance is very small and quite repeatable, and they have an excellent life expectancy (100,000 operations). The breakdown voltage between contacts is more than 12,000 volts, and this large voltage spacing helps minimize capacitive coupling between ranges. The insulation material is a ceramic with excellent dielectric and insulation properties even under high temperature and humidity conditions (30 degrees C, 75% RH). Finally, the mechanical rigidity of the range switch and its mounting means that the ac/dc differences at higher frequencies (up to and including 1 MHz) are unchanged even after the unit has been subjected to 2g random vibration testing.

Active Ranging. Millivolt level input voltages presented some technical challenges during the 792A's design. In order to achieve good dc performance as well as frequency flatness to 1 MHz, a composite amplifier approach was chosen. As an added complication, most calibrators have substantial output impedance at millivolt levels, so the 792A was required to have a very high input impedance to minimize loading errors. This was a bit of a struggle but finally we hit upon a fairly simple and unique noninverting composite amplifier topology.

Figure 6 presents the basic concept behind the non-inverting composite amplifier. For dc inputs, the circuit has the low offset voltage, low voltage noise and low bias current of the slow operational amplifier. For frequencies above about 3 Hz, the circuit displays the excellent frequency flatness of the fast op

amp. The closed loop gain of the circuit is given by $(R1+R2)/R1$ which is set at 3.3 for the 700 mV range and 10 for the 220 mV range. Two 10-gain circuits are cascaded for the 22 mV range.

While the composite amplifier alleviated some of the difficulties of making high precision millivolt ac measurements, some interesting problems still remained to be solved. Although the 792A is largely unaffected by external radiated electromagnetic interference (quite a bit of design effort was placed on meeting a very strict EMI

specification), these unwanted signals can upset the operation of the measuring voltmeter or the calibrator being used. More often, however, this radiated noise couples into the input wiring and is measured by the 792A along with the legitimate calibrator output. Fortunately, this condition is usually detected because it generally causes increased noise on the output of the 792A. By removing fluorescent lights, electric motors, soldering irons and so on from the vicinity of the test setup, one can essentially eliminate this problem.

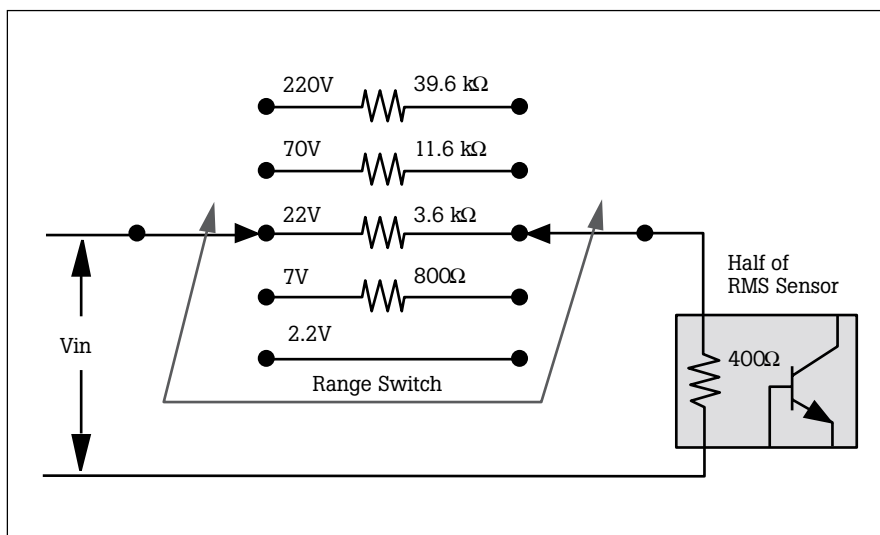

Figure 5: Simplified 792A Passive Range

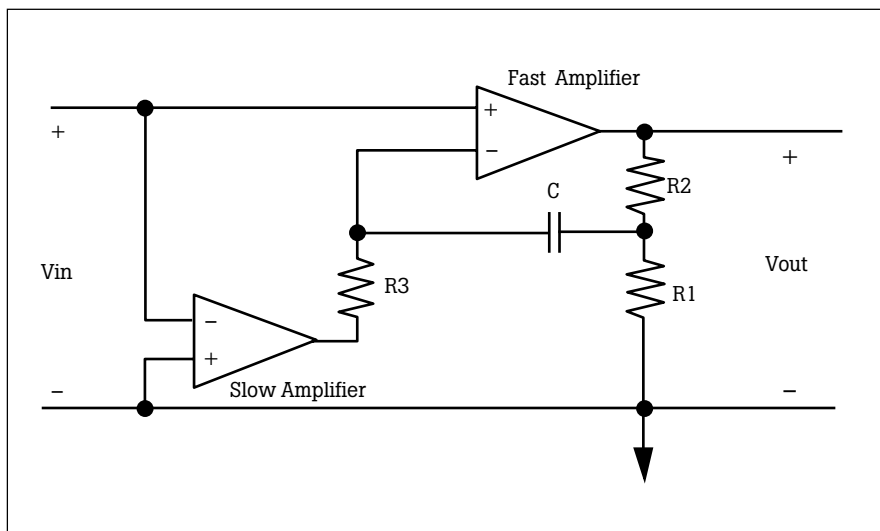

Figure 6: Noninverting Composite Amplifier

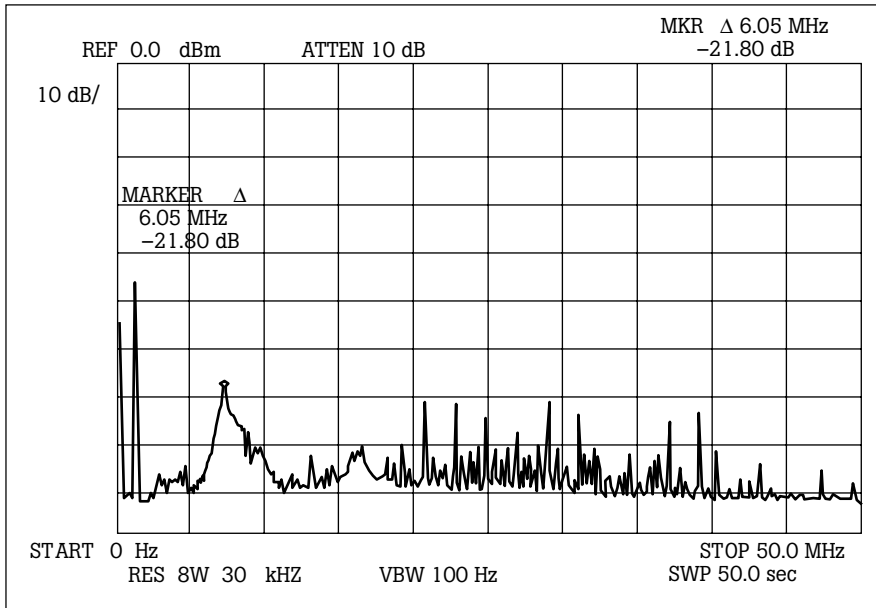

Figure 7: Spectrum of a Calibrator Output at 1 mV, 1 MHz

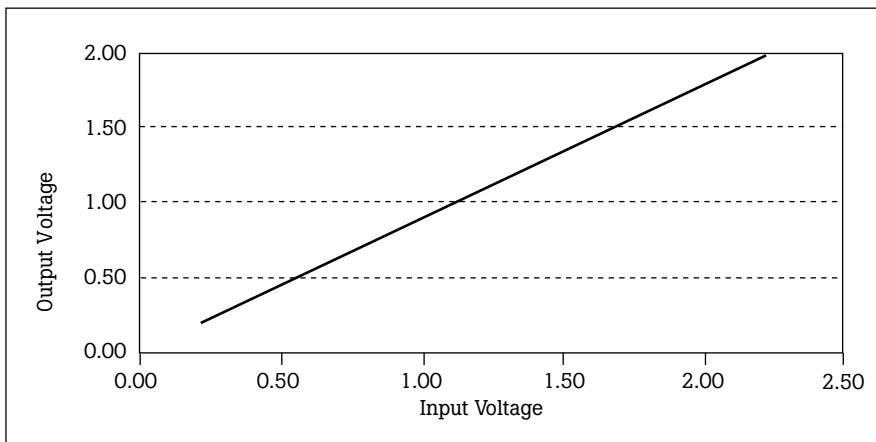

Figure 8: Linearity of 792A 2V Range: 0.22 to 2.2 Volts

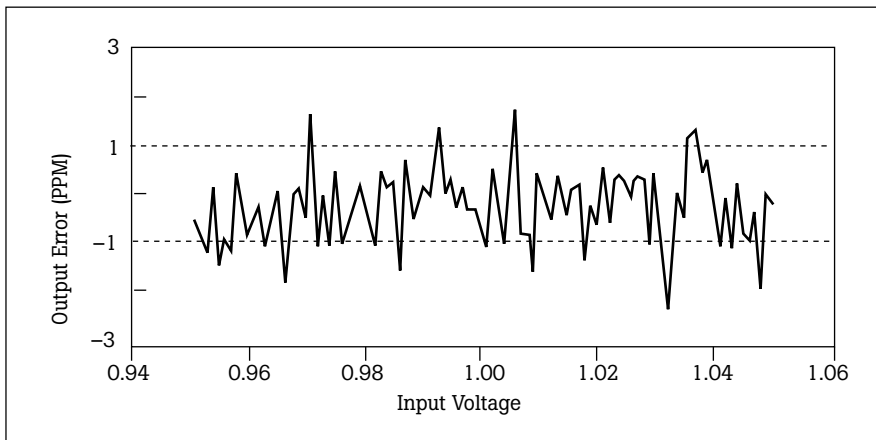

Figure 9: Linearity Error in 792A 2V Range: 0.95 to 1.05 Volts

A more insidious source of error can come from the calibration source itself. Figure 7 shows the output of a typical calibrator at 1 mV 1 MHz. Note that the 1 MHz signal is only contributing 99% of the total rms output while more than 1% is coming from spurious signals. Depending on the frequencies and amplitudes of the interfering signals, the measurement errors can be quite substantial. There are many methods for reducing or eliminating the errors caused by these spurious signals (such as using an external voltage divider), but one must always be conscious of this problem of spectral purity at all voltage levels.

Input Protection. A trade-off has always existed between input protection and high accuracy. The highest accuracy thermal converters offer no input overload protection, while some less accurate devices can withstand significant abuse.

From the beginning, a key design goal for the 792A was to provide high accuracy with robust input protection. Unfortunately, this proved difficult, and a few rms sensors were destroyed during testing. Fortunately, we reached a breakthrough. The resulting protection scheme proved extremely robust yet did not measurably affect the accuracy of the device.

While we certainly do not encourage anyone to intentionally overload the 792A, our testing with many different calibrator outputs demonstrates that it is able to withstand a 1000V input in any range without damage.

Evaluation

Linearity. One feature of the rms converter is that it converts ac voltage to dc voltage in a quasi-linear manner. From Figure 8, it can be seen that over its full range the converter is linear to the first order. However, for use as a high accuracy linear transfer standard, the device needs to be linear to

within a few ppm over the range of interest. Even with this tight tolerance, the 792A is linear when the range is restricted to +/- 5%.

Figure 9 shows a plot of the linearity error of a typical 792A, where:

$$e_o = (V_M - V_E) / V_M * 10^6$$

where e_o = output error in ppm

V_M = measured output voltage

V_E = expected output voltage

From this figure it can be seen that the error due to the 792A's nonlinearities is very small (less than 1 ppm), and that measurement noise is the largest contributor to output error.

Settling Time. The 792A settles to a valid output very quickly with negligible drift when compared to a TVC. Figure 10 compares the typical results of a 792A and a TVC for a full scale step input, where:

$$d_N = (V_{10} - V_N) / V_{10} * 10^6$$

where d_N = output drift after N seconds in ppm

V_{10} = output voltage at 10 seconds

V_N = output voltage at N seconds

For Figures 10, 11, and 12 the transfer devices were idle for ten minutes before the constant dc input was applied for twenty minutes. Notice that the TVC requires almost 10 minutes to stop drifting, while the 792A does not drift. Figure 11 compares the 792A and the TVC for a 1000V dc input. To make this graph the TVC was allowed to settle an additional ten seconds before recording the outputs. Note that the TVC drifted 25,000 ppm or 2.5% over the 20 minutes.

In both Figures 10 and 11 the 792A responses appear to be perfect. Of course they are not, and when its responses are plotted with much finer resolution, it can be seen that the 792A does require some time to settle when a full scale step response is applied to its input. Figure 12 shows how quickly it settles for a full scale step input for the 200 mV, 2V, and 1000V ranges.

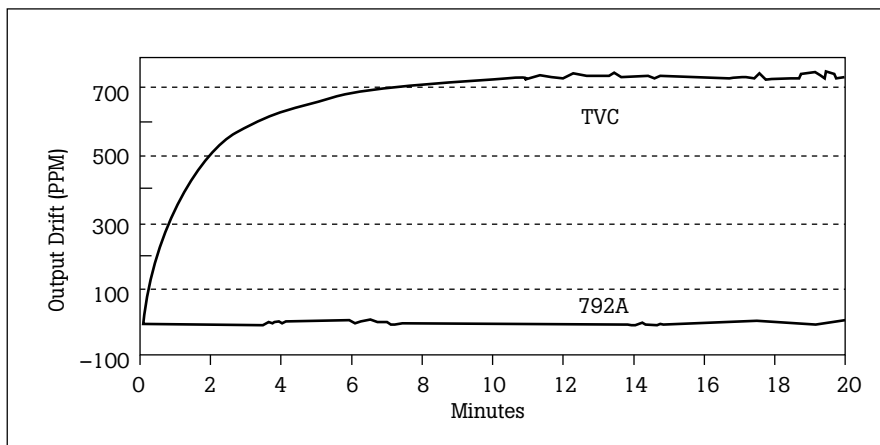

Figure 10: 792A Output Drift and Stability 2V Range

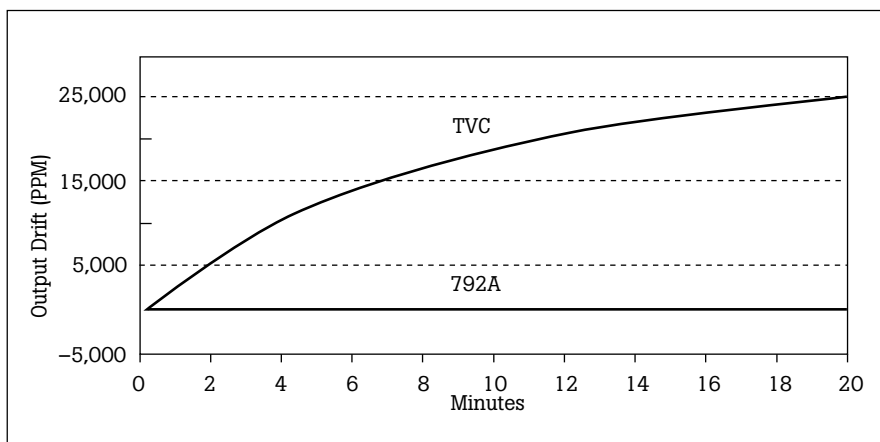

Figure 11: Output Drift and Stability 1000V Range

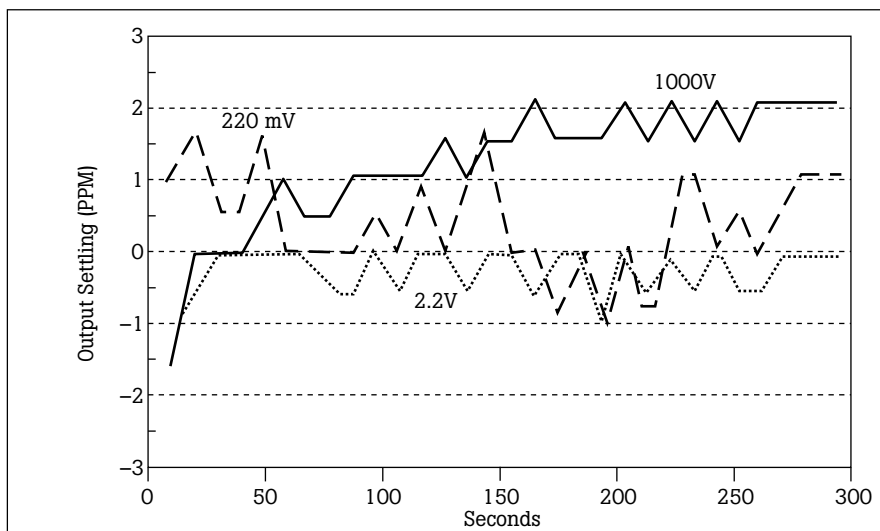

Figure 12: 792A Output Settling: 220 mV, 2V Ranges

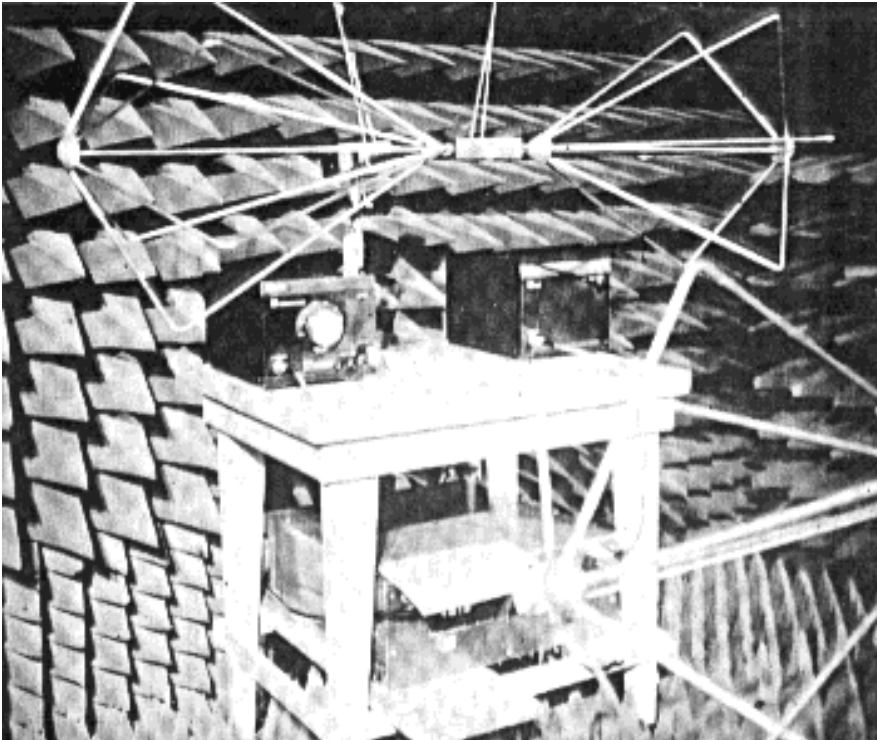

Figure 13: Electromagnetic Interference Immunity Test Setup.

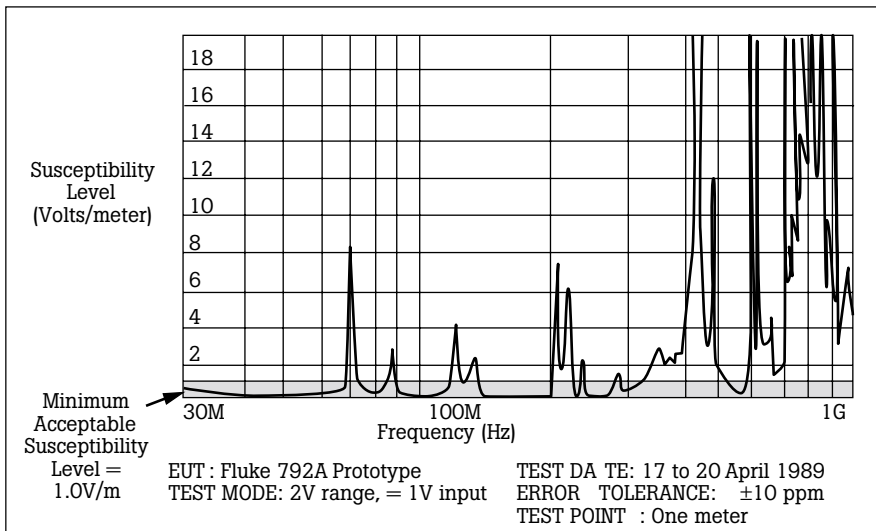

Figure 14: Radiated Susceptibility: MIL-T-28800D RS03 (Design Model)

Electromagnetic interference immunity

Many appliances found in a modern laboratory—PCs, fans, motors, florescent lights, etc.—create interference that can disrupt sensitive measurements.

To prevent corrupted measurements, all Fluke products are tested to assure that they surpass a minimum electrical interference immunity level.

Figure 13 shows the test setup that was used to find the electrical immunity. In this test, Radio Frequency (RF) signals are directed through an antenna at the 792A while it is performing a sensitive measurement. In order to determine the amount of RF energy necessary to disrupt operation to the 792A, the amplitude of the RF source is slowly increased until the sensitive measurement is corrupted. The result of this test is a graph of interference immunity vs. interfering signal frequency. Figure 14 shows the test results of a prototype model that failed to meet the minimum immunity requirement over many frequencies. Substantial design changes were made, including additional shielding and filtering.

Figure 15 shows the test results of a typical production model. This level of immunity is better than that of almost all voltage sources and voltmeters. Thus the 792A can be used in the average calibration environment for repeatable, high sensitivity ac/dc transfers without the need for elaborate and expensive EMI/RFI suppression and shielding procedures.

Conclusion

The 792A is a practical alternative to single and multi-junction TVCs in all ac/dc difference applications. It offers fast settling, high level linear output for all inputs from 2 mV to 1000V, while providing input protection up to 1000V on all ranges. At the Fluke Primary Standards Laboratory in Everett, Washington, the 792A has become the primary standard for voltages in the 10 Hz to 1 MHz range. By replacing TVCs and light beam galvanometers (which had been the previous standard) with the 792A, the Fluke Standards Laboratory is able to reduce the calibration time for a typical ac calibrator from 12 hours to less than three hours, while the time required to calibrate the ac section of a precision ac voltmeter fell from six hours to two hours. These calibration times could be reduced still further by taking full advantage of the 792A's low drift rate. Fluke Application Note "Semi-Automated AC Verification of the 5700A Calibrator" describes a system capable of calibrating a total of 49 frequencies in six ranges of the Fluke 5700A Calibrator in less than 20 minutes.

References

Leslie L. Szepesi, Jr, "Recent Developments on Solid State Thermal Voltage Converters", in Proceedings of Measurement Science Conference, 1986, pp. 9-13.

E. S. Williams, "Thermal Voltage Converters and Comparator for Very Accurate AC Voltage Measurements", Journal of Research of the National Bureau of Standards- C. Engineering and Instrumentation, Vol. 75C, Nos. 3 and 4, pp. 145-154, July-December 1971.

Les Huntley, "Establishing Traceability for a High Performance AC/DC Transfer Standard", in Proceedings of Measurement Science Conference, 1990, pp. 2B17 - 2B25.

D. Matson, "Using A Linear Thermal Transfer Standard for High Precision AC/DC Transfers", in Proceedings of Conference on Precision Electromagnetic Measurements, 1990.

Tom Withrow, "Semi-Automated Calibration of High Accuracy AC Calibrator", in Proceedings of National Conference of Standard Laboratories, 1990.

R. Henderson, N. Oldham, "New Low voltage Standards in the DC to 1 MHz Frequency Range", in Proceedings of Conference on Precision Electromagnetic Measurements, 1990.

This Technical Note is based on a paper presented at the 1990 NCSL Conference and Symposium by Bob Henderson and Don Matson and received the Dr. Allen V. Astin Award for best paper.

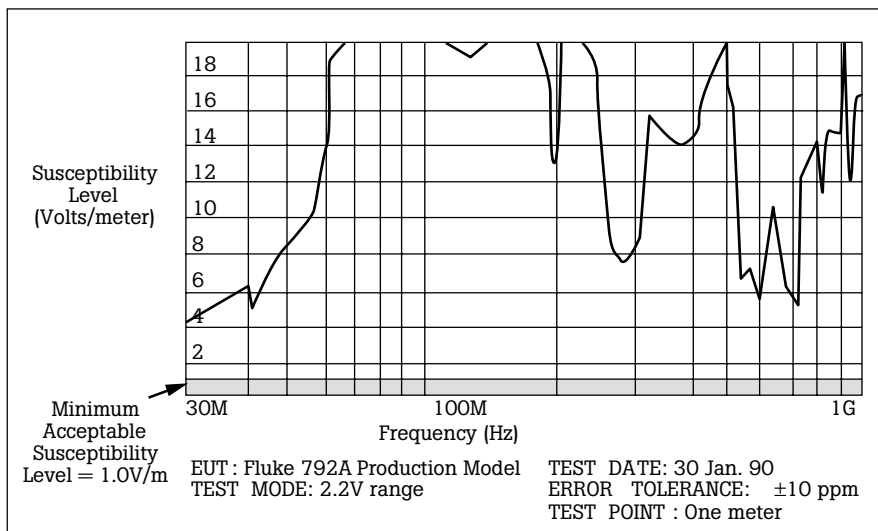

Figure 15: Radiated Susceptibility: MIL-T-28800D RS03 (Production Model)

Fluke. *Keeping your world
up and running.*

Fluke Corporation

PO Box 9090, Everett, WA USA 98206

Fluke Europe B.V.
PO Box 1186, 5602 BD
Eindhoven, The Netherlands

For more information call:
U.S.A. (800) 443-5853 or
Fax (425) 356-5116
Europe/M-East/Africa (31 40) 2 678 200 or
Fax (31 40) 2 678 222
Canada (800) 36-FLUKE or
Fax (905) 890-6866
Other countries (425) 356-5500 or
Fax (425) 356-5116
Web access: <http://www.fluke.com>

©2000 Fluke Corporation. All rights reserved.
Printed in U.S.A. 1/2000 1268781 A-ENG-N Rev B
Printed on recycled paper.